

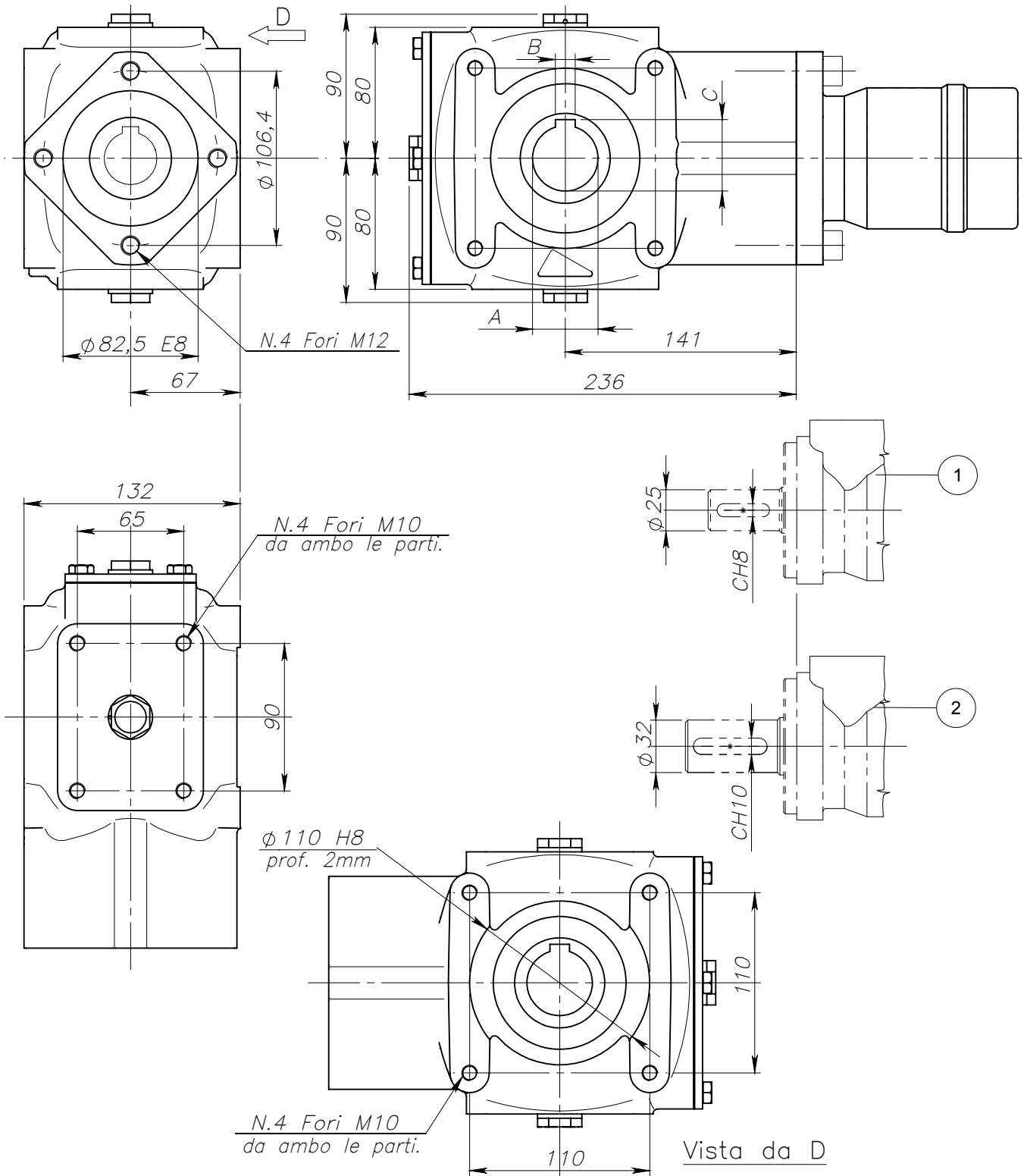

Riduttore RT 100



Marca	A E8	B E8	C	Attacco Motore	Peso kg	Rapporto	Mt in uscita Nm	Olio		Temperatura d'impiego:
								Tipo	Quantità kg	
15683	35	10	38,3	1	14	3,1:1	1000	SAE 90 EP	0,8	-20°C +80°C
15542	40	12	43,3							
15684	35	10	38,3	2						
15531	40	12	43,3							